

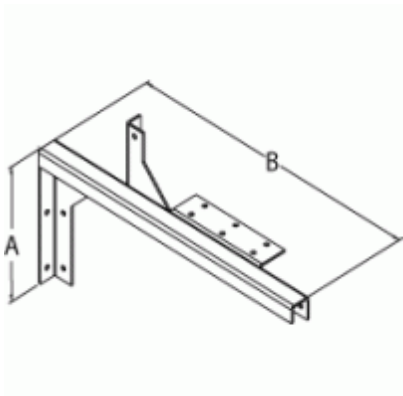

Quality Products. Service Excellence.

Bracket Hanger Wall Type *CWHW Series*



Painted Steel

Part No.	For use with	H	W
CWHW2	2.5 x 2.5	4.62	12.00
CWHW4	4 x 4	6.12	15.00
CWHW6	6 x 6	8.12	19.00
CWHW8	8 x 8	10.12	23.00
CWHW10	10 x 10	12.12	27.00
CWHW12	12 x 12	14.12	36.00

Unpainted Galvanized

Part No.	For use with	H	W
CWHW2G	2.5 x 2.5	4.62	12.00
CWHW4G	4 x 4	6.12	15.00
CWHW6G	6 x 6	8.12	19.00
CWHW8G	8 x 8	10.12	23.00
CWHW10G	10 x 10	12.12	27.00
CWHW12G	12 x 12	14.12	36.00



Data subject to change without notice

© 2021. Hammond Manufacturing Ltd. All rights reserved.